



**FITTING INSTRUCTIONS FOR RAD0269**  
**RADIATOR GUARD PAIR**  
**DUCATI MUTISTRADA V4 & V4S 2021-**



**THIS KIT CONTAINS THE ITEMS PICTURED AND LABELLED OVER PAGE.**

SOME PARTS MAY BE SHOWN FOR CLARITY OF INSTRUCTIONS ONLY.

DO NOT PROCEED UNTIL YOU ARE SURE ALL PARTS ARE PRESENT.

**PLEASE READ ALL INSTRUCTIONS BEFORE PROCEEDING.**

**IF IN ANY DOUBT WHEN FITTING OUR PRODUCTS, CONSULT ONE OF OUR DEALERS  
OR HAVE FITTED BY A QUALIFIED TECHNICIAN.**

PLEASE NOTE THAT THE WAY THE KIT IS PACKED DOES NOT NECESSARILY REPRESENT THE WAY OF  
MOUNTING TO THE BIKE.

IN THE EVENT OF RUBBER WASHERS BEING USED TO HOLD COMPONENTS ONTO BOLTS,  
THESE RUBBER WASHERS CAN BE THROWN AWAY.

**DIGITAL COPIES OF THESE INSTRUCTIONS ARE AVAILABLE FROM:**

[WWW.RG-RACING.COM](http://WWW.RG-RACING.COM)



<b><u>TOOLS REQUIRED</u></b>	<b><u>GENERAL TORQUE SETTINGS</u></b>
<ul style="list-style-type: none"> <li>• SET OF ALLEN KEYS TO INCLUDE 3mm.                             <ul style="list-style-type: none"> <li>• NEEDLE NOSE PLIERS.</li> <li>• CABLE CUTTERS OR SCISSORS.</li> </ul> </li> </ul>	<p>M4 BOLT = 8Nm                      M5 BOLT = 12Nm                      M6 BOLT = 15Nm                      M8 BOLT = 20Nm                      M10 BOLT = 40Nm                      M12 BOLT = 40Nm</p>

**LEGEND**

<b>ITEM NO.</b>	<b>DESCRIPTION</b>	<b>QTY</b>
ITEM 1	RAD0269 LHS RADIATOR GUARD	1
ITEM 2	RAD0269 RHS RADIATOR GUARD	1
ITEM 3	M5x10mm BUTTON HEAD BOLT	4
ITEM 4	M5x10MM O/D WASHER	4
ITEM 5	CT130 RADIATOR CABLE TIE (4-PACK)	2
ITEM 6	100mm SELF-ADHESIVE FOAM	4

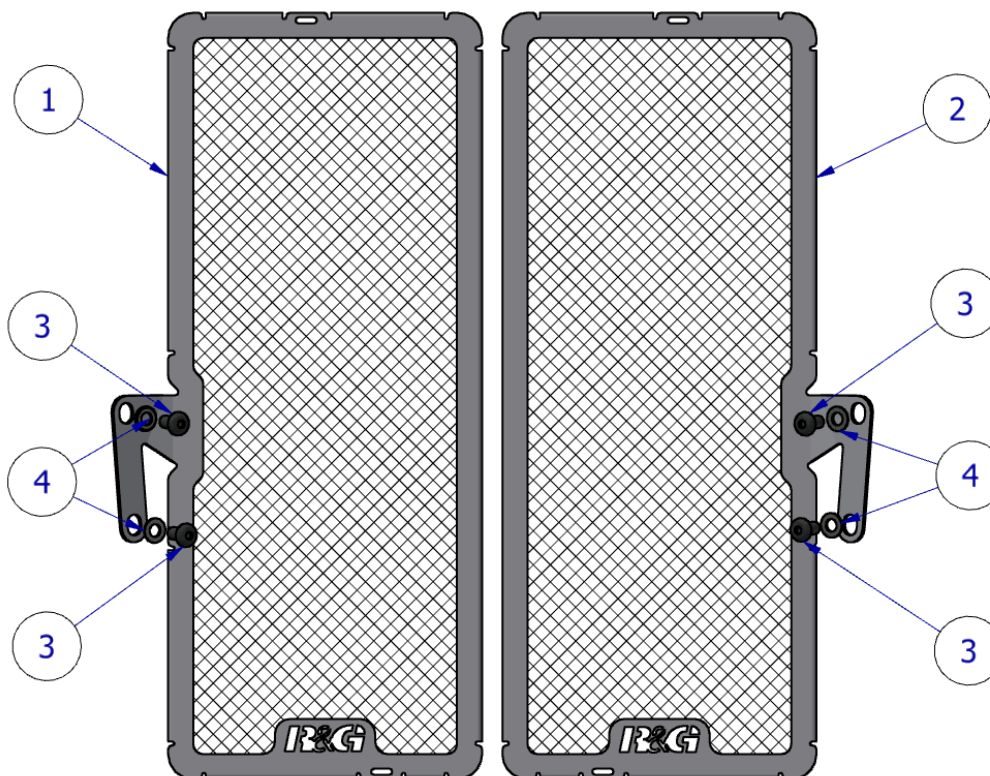

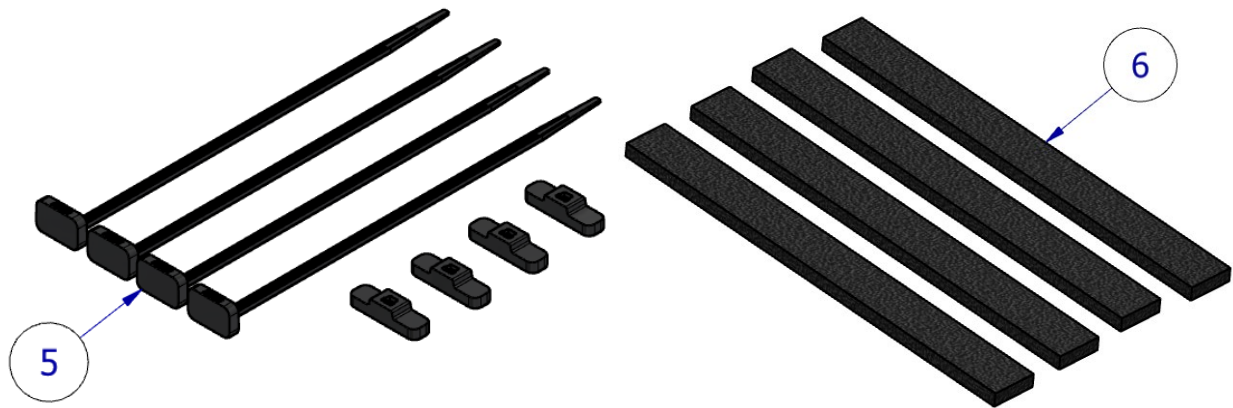

**FITTING PICTURES**

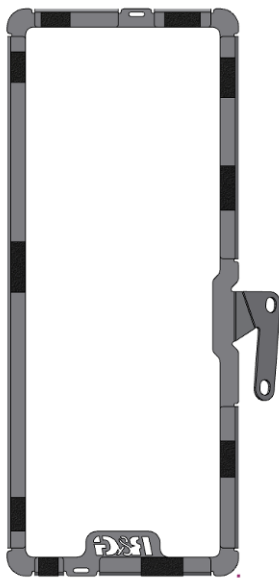

Picture 1

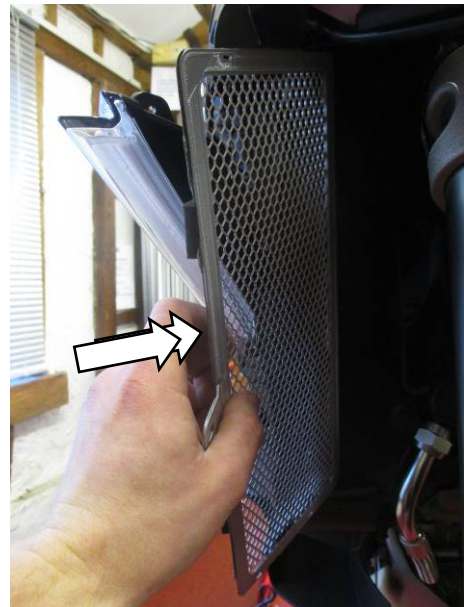

Picture 2

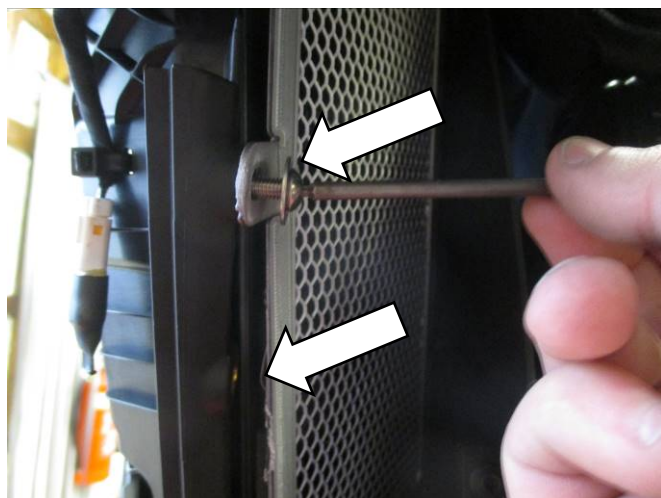

Picture 3

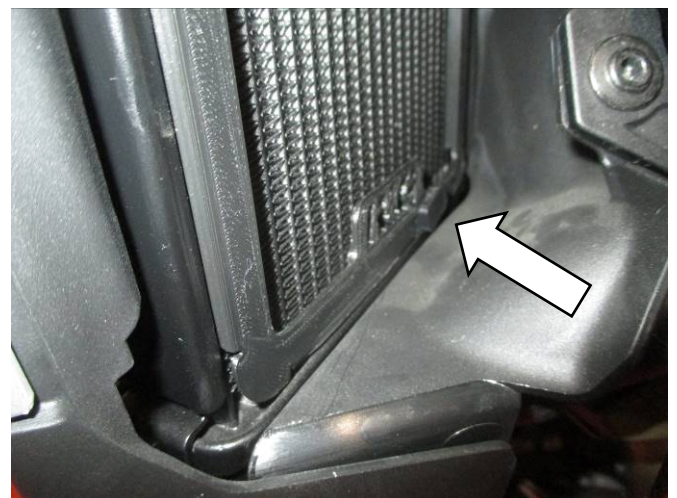

Picture 4

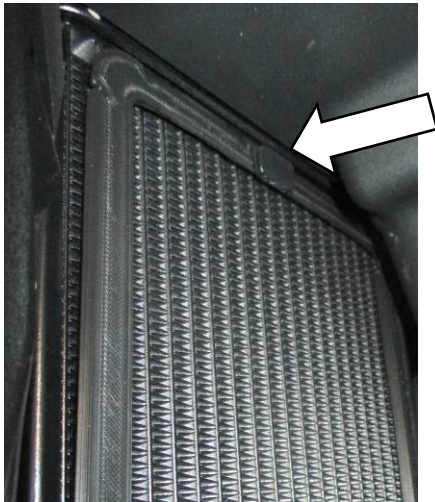

Picture 5



Picture 6

### **FITTING INSTRUCTIONS**

- To begin, cut the adhesive foam (item 6) provided into 10mm strips and affix onto the rear of the outer frame of each radiator guard in roughly the positions shown in **picture 1**.
- Slide LHS the radiator guard (item 1) into position ensuring the two mounting holes line up correctly and the guard fits neatly over the radiator, as shown in **picture 2**.
- Referring to the Assembly diagram on page 2, Use two M5 button head bolts (item 3) and M5 washers (item 4) to secure the radiator guard into place as shown in **picture 3**, do not fully tighten the bolts at this stage.
- Using two of the special radiator guard cable ties (Item 5), thread one cable tie through the upper and lower slots on the radiator guard as shown in **picture 4**, ensuring the tail goes through the outer matrix hole and to the back of the radiator matrix as shown in **picture 5**. Note, ensure the tie does not interfere with the fans on the rear of the radiator.
- Take one of the cable tie locking pieces and carefully attach top the back of the cable tie tail and slide up until it firmly holds the radiator in place, compressing the foam slightly as shown in **picture 6**. Do not overtighten as damage to the fins can occur.
- Once secure, trim the excess cable tie from the back of the radiator using a pair of snips.
- With cable ties now in place, fully tighten the securing bolts to the recommended torque.
- Repeat the process for the RHS radiator guard (item 2).
- Check all components are secure and all bolts are tight before riding.

ISSUE 1 - 15/11/2021 (DM)

### **CONSUMER NOTICE**

The catalogue description and any exhibition of samples are only broad indications of the Products and R&G may make design changes which do not diminish their performance or visual appeal and supplying them in such state shall conform to the order. The Buyer acknowledges no representation or warranty (other than as to title) has been given or will apply to the Products other than those in R&G's order or confirmation and the Buyer confirms it has chosen the Products as being of merchantable quality and suitable for its particular purposes. Where R&G fits the Products or undertakes other services it shall exercise reasonable skill and care and rectify any fault free of charge unless the workmanship has been disturbed. The Buyer is responsible for ensuring that the warranty on the motorcycle is not affected by the fitting of the Products. On return of any defective Products R&G shall at its option either supply a replacement or refund the purchase money but shall not be liable if the Products have been modified or used or maintained otherwise than in accordance with R&G's or manufacturer's instructions and good engineering practice or if the defect arises from accident or neglect. Other than identified above and subject to R&G not limiting its liability for causing death and personal injury, it shall not be liable for indirect or consequential loss and otherwise its liability shall be limited to the amounts paid by the Buyer for the Products or the fitting or service concerned. These terms do not affect the Buyer's statutory rights.

R&G Racing

Unit 1, Shelley's Lane, East Worldham, Alton, Hampshire, GU34 3AQ

Tel: +44 (0)1420 89007 Fax: +44 (0)1420 87301 [www.rg-racing.com](http://www.rg-racing.com) Email: [info@rg-racing.com](mailto:info@rg-racing.com)

**R&G RACING RETURNS POLICY (NON-FAULTY GOODS)**

Returns must be pre-authorized (if not pre-authorized the return will be rejected). Goods may only be returned direct to us if they were purchased direct from us (customer must prove if necessary). Otherwise to be returned to original vendor. Goods must be in re-sellable condition, in the opinion of R&G Racing. All returns are subject to a 25% restocking and handling fee (25% of the gross value exc. P&P – at the prevailing price at time of purchase). The customer must pay any and all carriage charges. No returns of discontinued products, unless within 14 days of purchase. This policy does not affect your statutory rights and does not refer to faulty goods.

R&G Racing

Unit 1, Shelley's Lane, East Worldham, Alton, Hampshire, GU34 3AQ

Tel: +44 (0)1420 89007 Fax: +44 (0)1420 87301 [www.rg-racing.com](http://www.rg-racing.com) Email: [info@rg-racing.com](mailto:info@rg-racing.com)



**NOTICE DE MONTAGE POUR RAD0269**  
**GRILLES DE RADIATEUR**  
**DUCATI MUTISTRADA V4 & V4S 2021-**



**CE KIT CONTIENT LES ARTICLES ILLUSTRÉS ET ÉTIQUETES SUR LA PAGE.**

CERTAINES PARTIES PEUVENT ÊTRE PRÉSENTES UNIQUEMENT POUR LA CLARTE DES INSTRUCTIONS.

NE PAS PROCÉDER AU MONTAGE TANT QUE VOUS N'ÊTES PAS SÛR QUE TOUTES LES PIÈCES SOIENT PRÉSENTES.

**VEUILLEZ LIRE TOUTES LES INSTRUCTIONS AVANT DE CONTINUER.**

**EN CAS DE DOUTE LORS DU MONTAGE DE NOS PRODUITS, CONSULTEZ UN DE NOS REVENDEURS OU FAITES APPEL À UN TECHNICIEN QUALIFIÉ.**

VEUILLEZ NOTER QUE LA FAÇON DONT LE KIT EST EMBALLÉ NE REPRÉSENTE PAS NECESSAIREMENT LA MANIÈRE DE LE MONTER SUR LA MOTO.

SI DES RONDELLES EN CAOUTCHOUC SONT UTILISÉES POUR MAINTENIR LES COMPOSANTS SUR LES BOULONS, ELLES PEUVENT ÊTRE JETÉES.

**NOTICE DISPONIBLE AU TÉLÉCHARGEMENT SUR :**

[WWW.RG-RACING.COM](http://WWW.RG-RACING.COM)

R&G Racing

Unit 1, Shelley's Lane, East Worldham, Alton, Hampshire, GU34 3AQ

Tel: +44 (0)1420 89007 Fax: +44 (0)1420 87301 [www.rg-racing.com](http://www.rg-racing.com) Email: [info@rg-racing.com](mailto:info@rg-racing.com)



<b><u>OUTIL REQUIS</u></b>	<b><u>VALEURS DE SERRAGE</u></b>
<ul style="list-style-type: none"> <li>• CLÉS ALLEN 3mm.</li> <li>• PINCE À BEC.</li> <li>• PINCE COUPANTE.</li> </ul>	M4 BOULON = 8Nm M5 BOULON = 12Nm M6 BOULON = 15Nm M8 BOULON = 20Nm M10 BOULON = 40Nm M12 BOULON = 40Nm

### **LÉGENDE**

<b>ARTICLE NO.</b>	<b>DESCRIPTION</b>	<b>QTÉ</b>
ARTICLE 1	RAD0269 GRILLE DE PROTECTION RADIATEUR CÔTÉ GAUCHE	1
ARTICLE 2	RAD0269 GRILLE DE PROTECTION RADIATEUR CÔTÉ DROIT	1
ARTICLE 3	M5x10mm BOULON	4
ARTICLE 4	M5x10MM RONDELLE	4
ARTICLE 5	CT130 COLLIER DE SERRAGE DE RADIATEUR (4-PACK)	2
ARTICLE 6	100mm MOUSSE AUTOCOLLANTE	4

R&G Racing

Unit 1, Shelley's Lane, East Worldham, Alton, Hampshire, GU34 3AQ

Tel: +44 (0)1420 89007 Fax: +44 (0)1420 87301 [www.rg-racing.com](http://www.rg-racing.com) Email: [info@rg-racing.com](mailto:info@rg-racing.com)

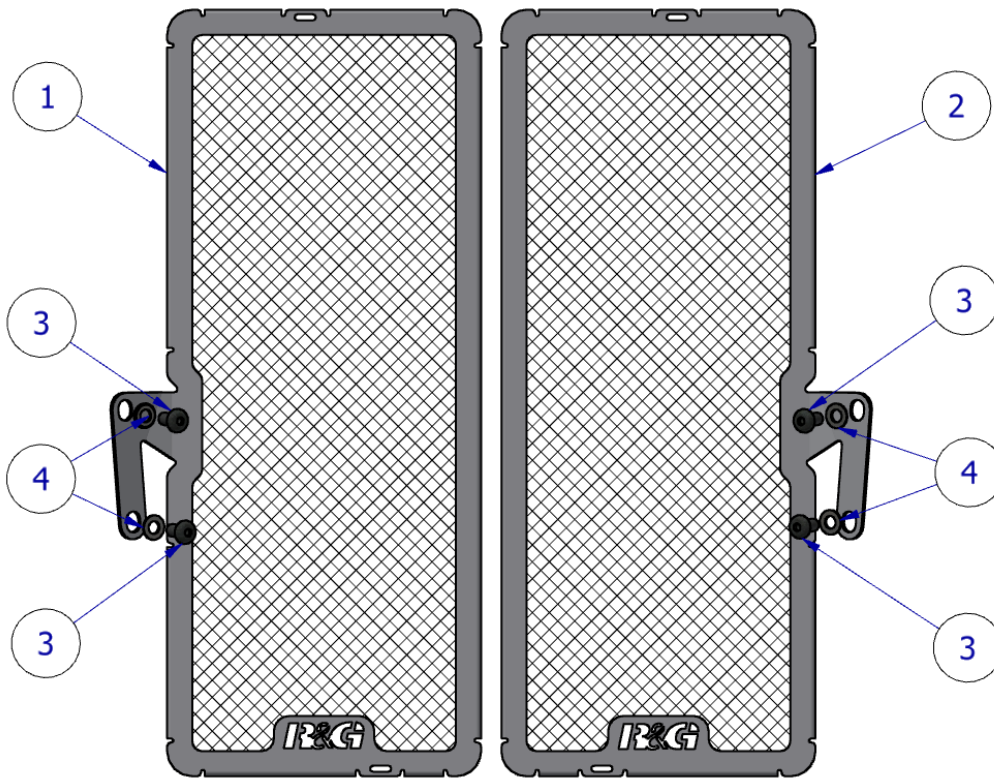



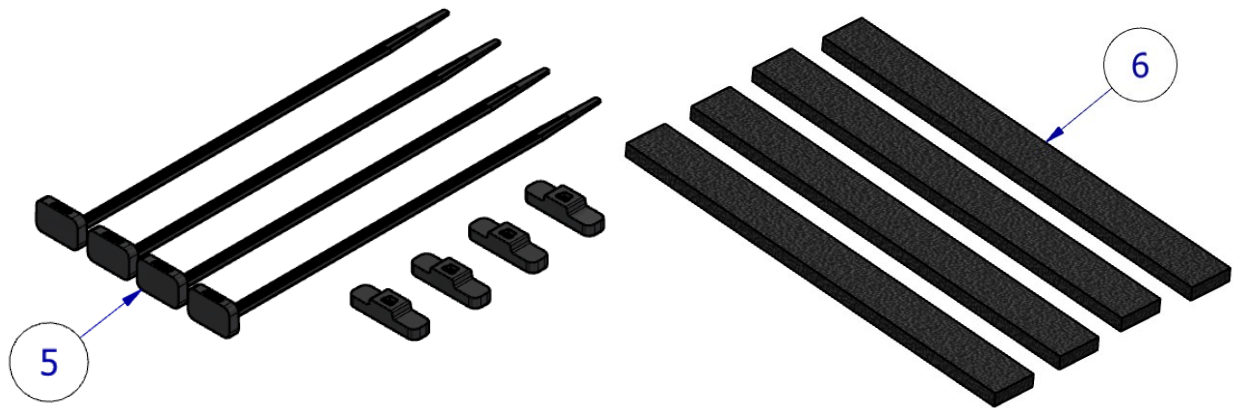

**PHOTOS DE MONTAGE**

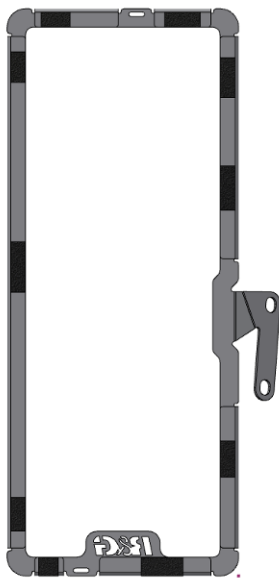

Photo 1

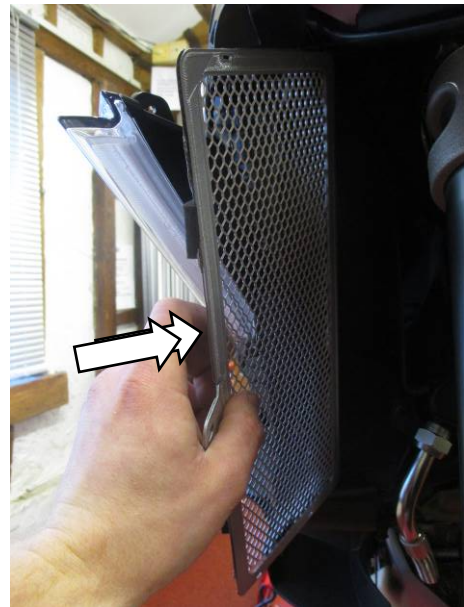

Photo 2

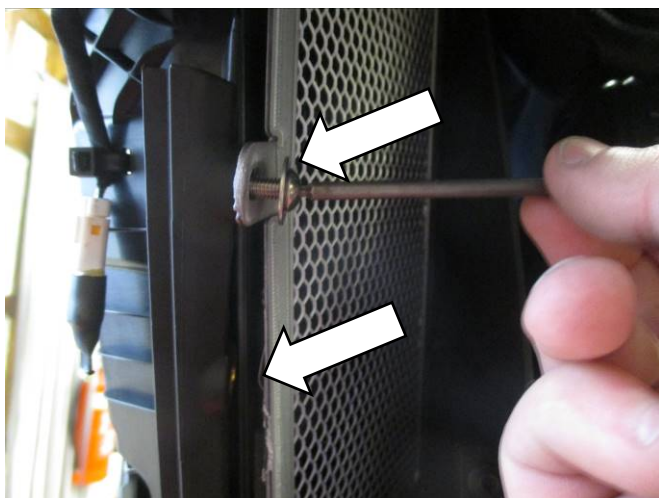

Photo 3

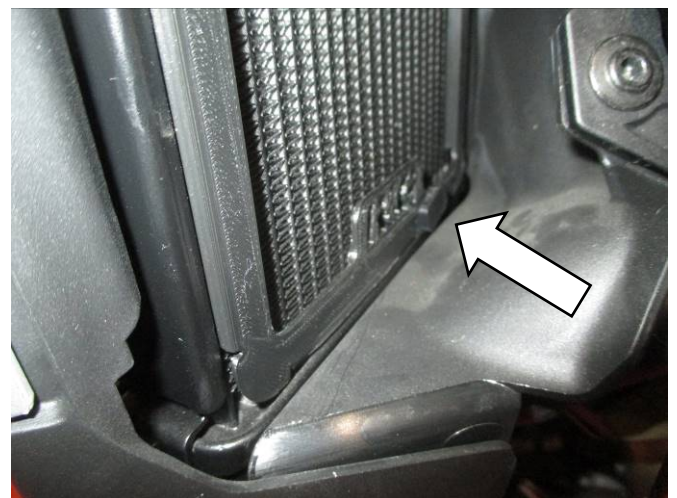

Photo 4

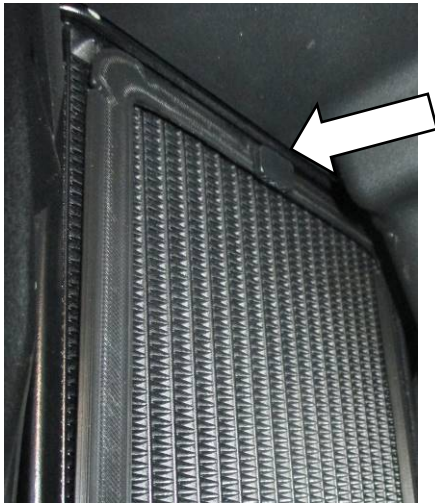

Photo 5



Photo 6

### NOTICE DE MONTAGE

- Pour commencer, découpez la mousse adhésive (article 6) fournie en bandes de 10 mm et collez-la sur l'arrière du cadre extérieur de chaque grille de protection dans les positions indiquées sur la photo 1.
- Faites glisser la protection radiateur côté gauche (article 1) en position en vous assurant que les deux trous de montage s'alignent correctement et que le protège-radiateur s'adapte parfaitement sur le radiateur, comme illustré sur la photo 2.
- En vous référant au schéma de montage page 2, utilisez deux boulons à tête ronde M5 (article 3) et des rondelles M5 (article 4) pour fixer le protège-radiateur en place comme indiqué sur la photo 3, ne serrez pas complètement les boulons à ce stade.
- À l'aide de deux des attache-câbles spéciaux de protection radiateur (article 5), enfiler une attache de câble dans les fentes supérieure et inférieure de la protection de radiateur, comme indiqué sur la photo 4, en vous assurant que la queue passe par le trou de la matrice externe et à l'arrière de la matrice de radiateur comme indiqué sur la photo 5. Remarque, assurez-vous que l'attache n'interfère pas avec les ventilateurs à l'arrière du radiateur.
- Prenez l'une des pièces de verrouillage de l'attache de câble et fixez soigneusement l'arrière de la queue de l'attache de câble et faites-la glisser jusqu'à ce qu'elle maintienne fermement le radiateur en place, en comprimant légèrement la mousse comme indiqué sur la photo 6. Ne pas trop serrer car cela endommagerait les ailettes.
- Une fois fixé, coupez l'excès d'attache de câble à l'arrière du radiateur à l'aide d'une paire de cisailles.
- Une fois les attaches de câble en place, serrez complètement les boulons de fixation au couple recommandé.
- Répétez le processus pour la protection radiateur côté droit (article 2).
- Vérifiez que tous les composants soient sécurisés et que tous les boulons soient serrés avant de rouler.

ISSUE 1 - 15/11/2021 (DM)

#### CONSUMER NOTICE

The catalogue description and any exhibition of samples are only broad indications of the Products and R&G may make design changes which do not diminish their performance or visual appeal and supplying them in such state shall conform to the order. The Buyer acknowledges no representation or warranty (other than as to title) has been given or will apply to the Products other than those in R&G's order or confirmation and the Buyer confirms it has chosen the Products as being of merchantable quality and suitable for its particular purposes. Where R&G fits the Products or undertakes other services it shall exercise reasonable

R&G Racing

Unit 1, Shelley's Lane, East Worldham, Alton, Hampshire, GU34 3AQ

Tel: +44 (0)1420 89007 Fax: +44 (0)1420 87301 [www.rg-racing.com](http://www.rg-racing.com) Email: [info@rg-racing.com](mailto:info@rg-racing.com)



skill and care and rectify any fault free of charge unless the workmanship has been disturbed. The Buyer is responsible for ensuring that the warranty on the motorcycle is not affected by the fitting of the Products. On return of any defective Products R&G shall at its option either supply a replacement or refund the purchase money but shall not be liable if the Products have been modified or used or maintained otherwise than in accordance with R&G's or manufacturer's instructions and good engineering practice or if the defect arises from accident or neglect. Other than identified above and subject to R&G not limiting its liability for causing death and personal injury, it shall not be liable for indirect or consequential loss and otherwise its liability shall be limited to the amounts paid by the Buyer for the Products or the fitting or service concerned. These terms do not affect the Buyer's statutory rights.

**R&G RACING RETURNS POLICY (NON-FAULTY GOODS)**

Returns must be pre-authorized (if not pre-authorized the return will be rejected). Goods may only be returned direct to us if they were purchased direct from us (customer must prove if necessary). Otherwise to be returned to original vendor. Goods must be in re-sellable condition, in the opinion of R&G Racing. All returns are subject to a 25% restocking and handling fee (25% of the gross value exc. P&P – at the prevailing price at time of purchase). The customer must pay any and all carriage charges. No returns of discontinued products, unless within 14 days of purchase. This policy does not affect your statutory rights and does not refer to faulty goods.

R&G Racing

Unit 1, Shelley's Lane, East Worldham, Alton, Hampshire, GU34 3AQ

Tel: +44 (0)1420 89007 Fax: +44 (0)1420 87301 [www.rg-racing.com](http://www.rg-racing.com) Email: [info@rg-racing.com](mailto:info@rg-racing.com)



**MONTAGEANLEITUNG FÜR RAD0269**  
**KÜHLERSCHUTZ PAAR**  
**DUCATI MULTISTRADA V4 & V4S 2021-**



**ALLE KIT-TEILE SIND AUF DEN NACHFOLGENDEN SEITEN ABGEBILDET UND GEKENNZEICHNET.**

DIE ABGEBILDETEN TEILE DIENEN LEDIGLICH ZUR ERKLÄRUNG.

ÜBERPRÜFEN SIE ZUERST, DASS ALLE TEILE VORHANDEN SIND.

**LESEN SIE DIE MONTAGEANLEITUNG KOMPLETT DURCH, BEVOR SIE ANFANGEN.**

**WENN SIE BEI DER MONTAGE DIESES PRODUKTES UNSICHER SIND, BITTE EINEN UNSERER HÄNDLER KONTAKTIEREN ODER DAS KIT VON EINEM QUALIFIZIERTEN ZWEIRAD-MECHANIKER MONTIEREN LASSEN.**

DIE VERPACKUNG DER TEILE STELLT NICHT DIE REIHENFOLGE DER MONTAGE DAR.

HINWEIS FÜR KITS MIT PLASTIKUNTERLEGSCHLEIBEN AN DEN SCHRAUBEN –  
DIESE PLASTIK-UNTERLEGSCHLEIBEN WERDEN NICHT FÜR DEN EINBAU BENÖTIGT.

**EINE DIGITALE VERSION DIESER MONTAGEANLEITUNG KANN AUF FOLGENDER SEITE HERUNTERGELADEN WERDEN:**

[WWW.RG-RACING.COM](http://WWW.RG-RACING.COM)

R&G Racing

Unit 1, Shelley's Lane, East Worldham, Alton, Hampshire, GU34 3AQ

Tel: +44 (0)1420 89007 Fax: +44 (0)1420 87301 [www.rg-racing.com](http://www.rg-racing.com) Email: [info@rg-racing.com](mailto:info@rg-racing.com)



<b>SIE BENÖTIGEN FOLGENDES WERKZEUG</b>	<b>ALLGEM. ANZUGSDREHMOMENT</b>
<ul style="list-style-type: none"> <li>• SATZ INBUSSCHLÜSSEL INKL. 3mm               <ul style="list-style-type: none"> <li>• SPITZZANGE</li> </ul> </li> <li>• SEITENSCHNEIDER ODER SCHERE</li> </ul>	M4 SCHRAUBE = 8Nm M5 SCHRAUBE = 12Nm M6 SCHRAUBE = 15Nm M8 SCHRAUBE = 20Nm M10 SCHRAUBE = 40Nm M12 SCHRAUBE = 40Nm

### **LIEFERUMFANG**

<b>ARTIKEL NO.</b>	<b>BESCHREIBUNG</b>	<b>MENGE</b>
ARTIKEL 1	RAD0269 KÜHLERSCHUTZ LINKE SEITE	1
ARTIKEL 2	RAD0269 KÜHLERSCHUTZ RECHTE SEITE	1
ARTIKEL 3	M5x10mm INBUSSCHLÜSSEL	4
ARTIKEL 4	M5x10MM O/D UNTERLEGSSCHEIBE	4
ARTIKEL 5	CT130 KÜHLER KABELBINDER (4er PACK)	2
ARTIKEL 6	100mm SELBSTKLEBENDER SCHAUMSTOFF	4

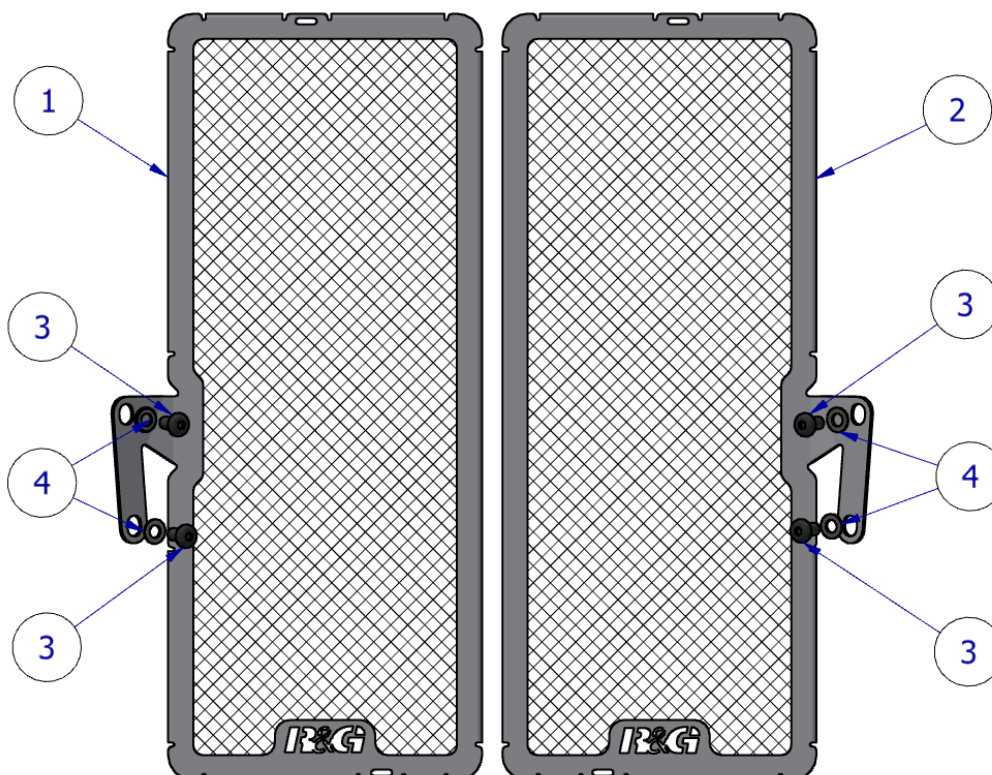

R&G Racing

Unit 1, Shelley's Lane, East Worldham, Alton, Hampshire, GU34 3AQ

Tel: +44 (0)1420 89007 Fax: +44 (0)1420 87301 [www.rg-racing.com](http://www.rg-racing.com) Email: [info@rg-racing.com](mailto:info@rg-racing.com)

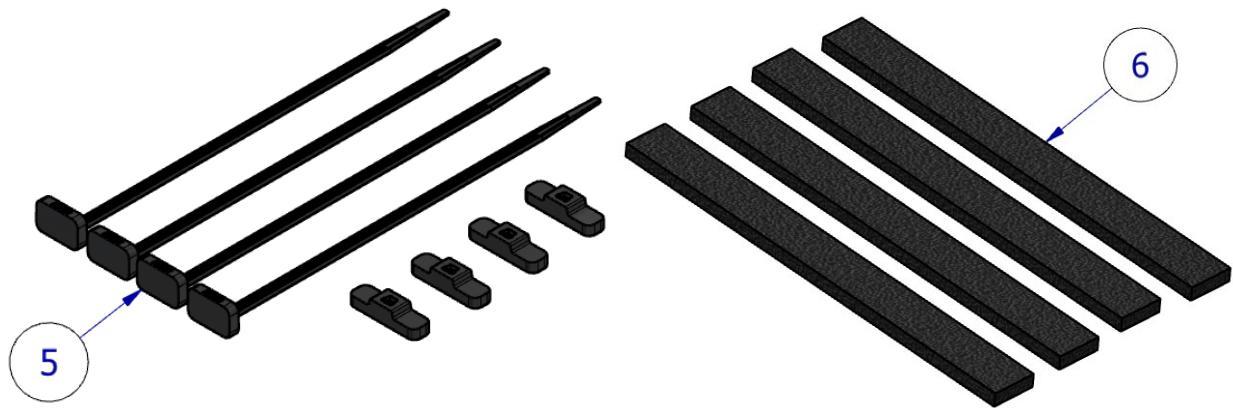

**MONTAGE ABILDUNGEN**



Abbildung 1



Abbildung 2

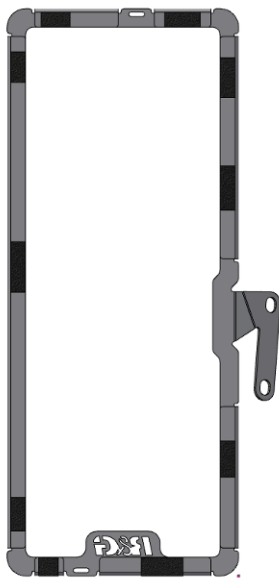

Abbildung 3

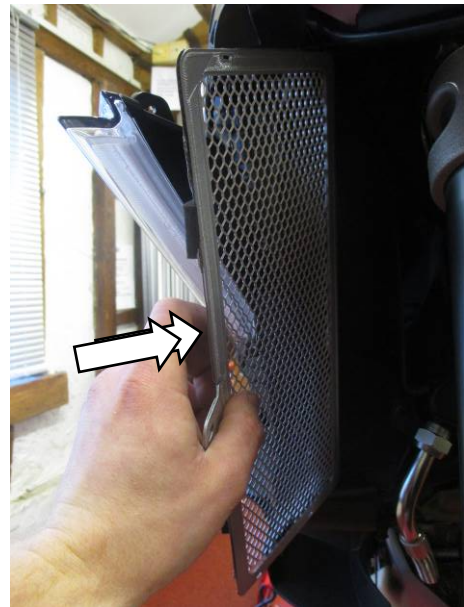

Abbildung 4

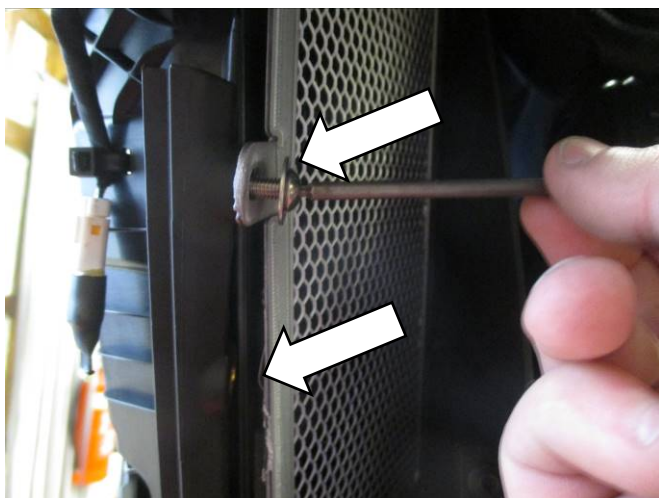

Abbildung 5

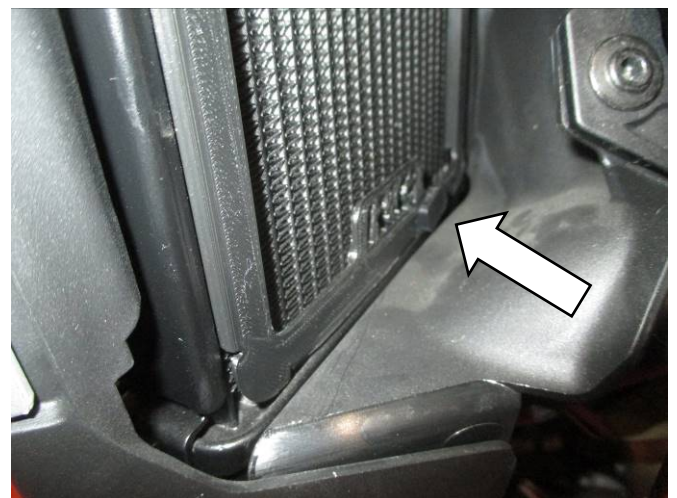

Abbildung 6

### **MONTAGEANLEITUNG**

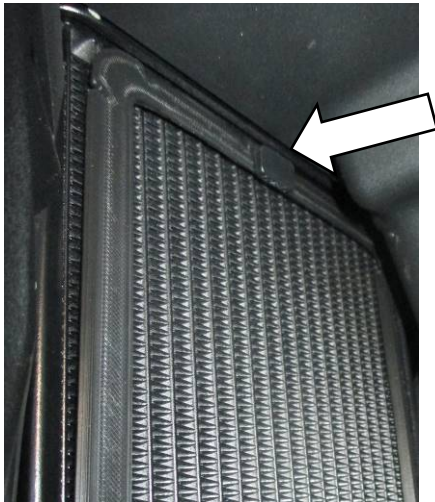
- Schneiden Sie zuerst den selbstklebenden Schaumstoff vom Kit (Artikel 6) in 10mm Streifen und kleben Sie diese auf der Rückseite des äußeren Rahmens am jeweiligen Kühlerschutz – wenn möglich an den gleichen Positionen wie in **Abbildung 1** abgebildet.
- Schieben Sie den Kühlerschutz für die linke Seite (Artikel 1) in Position. Achten Sie darauf, dass die zwei Montageöffnungen bündig sind und der Kühlerschutz am Kühler sitzt wie in **Abbildung 2** abgebildet.
- Die Zeichnung Zusammenbau auf Seite 2 dient als Referenz für den nächsten Schritt: Benutzen Sie zwei M5 Inbusschrauben (Artikel 3) und M5 Unterlegscheiben (Artikel 4), um den Kühlerschutz in Position zu befestigen wie in **Abbildung 3** abgebildet – die Schrauben zu diesem Zeitpunkt nicht komplett festziehen.
- Nehmen Sie zwei der speziellen Kabelbinder für den Kühlerschutz (Artikel 5) und fädeln Sie einen Kabelbinder durch den oberen und unteren Schlitz des Kühlerschutzes wie in **Abbildung 4** abgebildet. Stellen Sie sicher, dass das Kabelband durch die äußere Matrixöffnung und in die Rückseite des Kühler-Matrix geführt wurde wie in **Abbildung 5** abgebildet. Hinweis: Achten Sie darauf, dass der Kabelbinder die Lüfter an der Rückseite des Kühlers nicht beeinträchtigen.
- Nehmen Sie ein Verschlussstück für einen Kabelbinder und dies vorsichtig an der Rückseite des Kabelband anbringen und nach oben schieben, bis es den Kühler sicher in Position fixiert – der Schaumstoff wird hierbei etwas zusammengedrückt wie in **Abbildung 6** abgebildet. Nicht zu fest anziehen, um Beschädigungen zu vermeiden.
- Wenn alles sicher ist, das überschüssige Kabelband hinten am Kühler mit einem Seitenscheider oder einer Schere abschneiden.
- Nachdem die Kabelbinder montiert wurden, ziehen Sie die Befestigungsschrauben mit dem empfohlenen Anzugsdrehmoment fest.
- Wiederholen Sie die oben beschriebenen Schritte nochmal mit dem Kühlerschutz für die rechte Seite (Artikel 2).
- Überprüfen Sie, dass alle Komponenten sicher befestigt sind und alle Schrauben fest angezogen sind, bevor Sie mit dem Motorrad fahren.

AUSGABE 1 – 15/11/2021 (DM)

R&G Racing

Unit 1, Shelley's Lane, East Worldham, Alton, Hampshire, GU34 3AQ

Tel: +44 (0)1420 89007 Fax: +44 (0)1420 87301 [www.rg-racing.com](http://www.rg-racing.com) Email: [info@rg-racing.com](mailto:info@rg-racing.com)

**CONSUMER NOTICE**

The catalogue description and any exhibition of samples are only broad indications of the Products and R&G may make design changes which do not diminish their performance or visual appeal and supplying them in such state shall conform to the order. The Buyer acknowledges no representation or warranty (other than as to title) has been given or will apply to the Products other than those in R&G's order or confirmation and the Buyer confirms it has chosen the Products as being of merchantable quality and suitable for its particular purposes. Where R&G fits the Products or undertakes other services it shall exercise reasonable skill and care and rectify any fault free of charge unless the workmanship has been disturbed. The Buyer is responsible for ensuring that the warranty on the motorcycle is not affected by the fitting of the Products. On return of any defective Products R&G shall at its option either supply a replacement or refund the purchase money but shall not be liable if the Products have been modified or used or maintained otherwise than in accordance with R&G's or manufacturer's instructions and good engineering practice or if the defect arises from accident or neglect. Other than identified above and subject to R&G not limiting its liability for causing death and personal injury, it shall not be liable for indirect or consequential loss and otherwise its liability shall be limited to the amounts paid by the Buyer for the Products or the fitting or service concerned. These terms do not affect the Buyer's statutory rights.

**R&G RACING RETURNS POLICY (NON-FAULTY GOODS)**

Returns must be pre-authorized (if not pre-authorized the return will be rejected). Goods may only be returned direct to us if they were purchased direct from us (customer must prove if necessary). Otherwise to be returned to original vendor. Goods must be in re-sellable condition, in the opinion of R&G Racing. All returns are subject to a 25% restocking and handling fee (25% of the gross value exc. P&P – at the prevailing price at time of purchase). The customer must pay any and all carriage charges. No returns of discontinued products, unless within 14 days of purchase. This policy does not affect your statutory rights and does not refer to faulty goods.

R&G Racing

Unit 1, Shelley's Lane, East Worldham, Alton, Hampshire, GU34 3AQ

Tel: +44 (0)1420 89007 Fax: +44 (0)1420 87301 [www.rg-racing.com](http://www.rg-racing.com) Email: [info@rg-racing.com](mailto:info@rg-racing.com)