

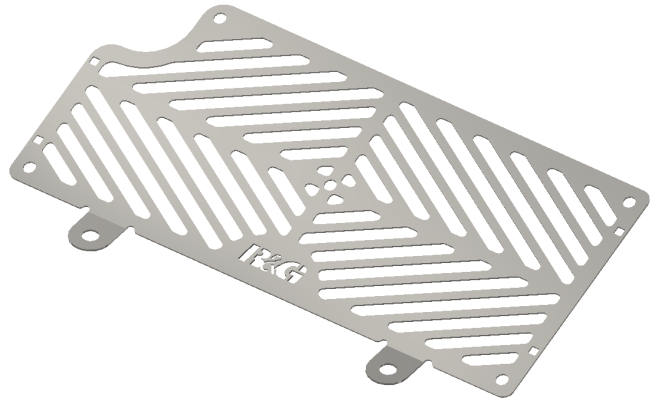

FITTING INSTRUCTIONS FOR SCG0017SS
STAINLESS OIL COOLER GUARD
FOR KAWASAKI NINJA ZX-10R/RR 2021-



THIS KIT CONTAINS THE ITEMS PICTURED AND LABELLED OVER PAGE.

SOME PARTS MAY BE SHOWN FOR CLARITY OF INSTRUCTIONS ONLY.

DO NOT PROCEED UNTIL YOU ARE SURE ALL PARTS ARE PRESENT.

PLEASE READ ALL INSTRUCTIONS BEFORE PROCEEDING.

**IF IN ANY DOUBT WHEN FITTING OUR PRODUCTS, CONSULT ONE OF
OUR DEALERS OR HAVE FITTED BY A QUALIFIED TECHNICIAN.**

PLEASE NOTE THAT THE WAY THE KIT IS PACKED DOES NOT NECESSARILY REPRESENT THE
WAY OF MOUNTING TO THE BIKE.

IN THE EVENT OF RUBBER WASHERS BEING USED TO HOLD COMPONENTS ONTO BOLTS,
THESE RUBBER WASHERS CAN BE THROWN AWAY.

DIGITAL COPIES OF THESE INSTRUCTIONS ARE AVAILABLE FROM:

WWW.RG-RACING.COM



<u>TOOLS REQUIRED</u>	<u>GENERAL TORQUE SETTINGS</u>
<ul style="list-style-type: none">• Allen key set to include 4 & 5mm A/F.<ul style="list-style-type: none">• 10mm spanner or socket.• Phillips and flat bladed driver.<ul style="list-style-type: none">• Cable cutters.	M4 BOLT = 8Nm M5 BOLT = 12Nm M6 BOLT = 15Nm M8 BOLT = 20Nm M10 BOLT = 40Nm M12 BOLT = 40Nm

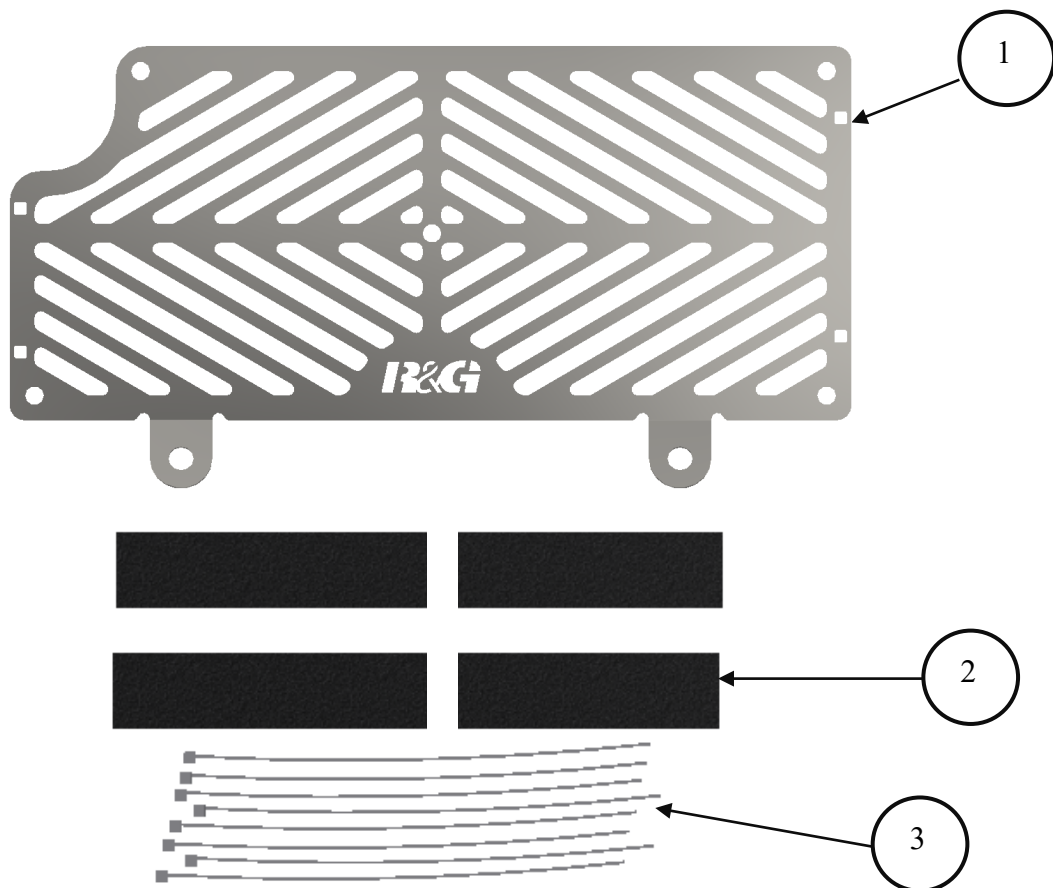

COMPONENT DIAGRAM



LEGEND

ITEM NO.	DESCRIPTION	QTY
ITEM 1	STAINLESS OIL COOLER GUARD (SCG0017SS)	1
ITEM 2	SELF ADHESIVE FOAM x 100mm LONG	4
ITEM 3	2.5mm CABLE TIES	8



PICTURE 1



PICTURE 2

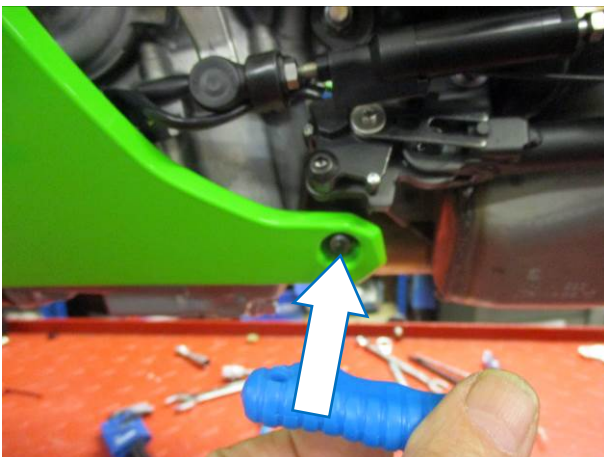

PICTURE 3



PICTURE 4



PICTURE 5



PICTURE 6

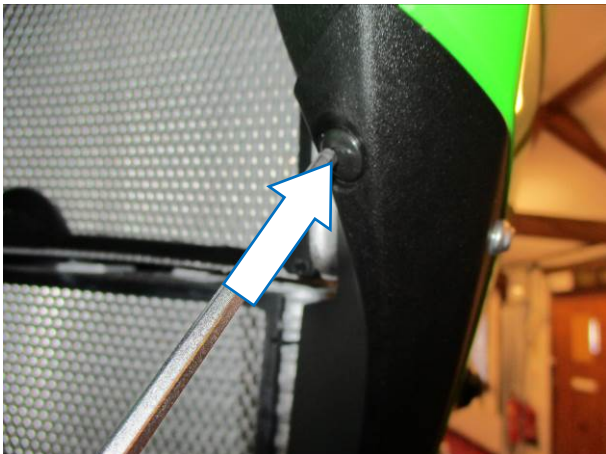

PICTURE 7

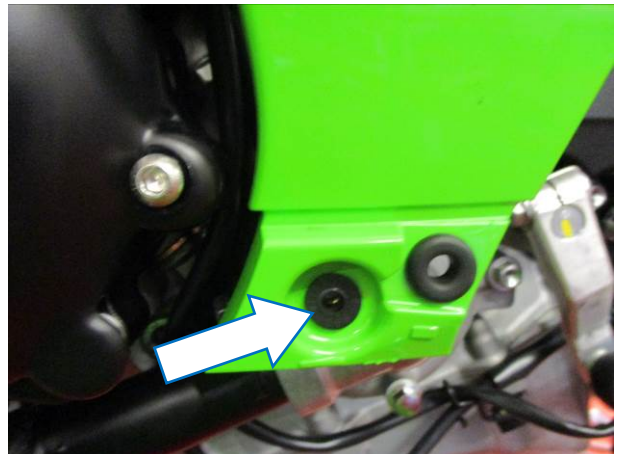

PICTURE 8

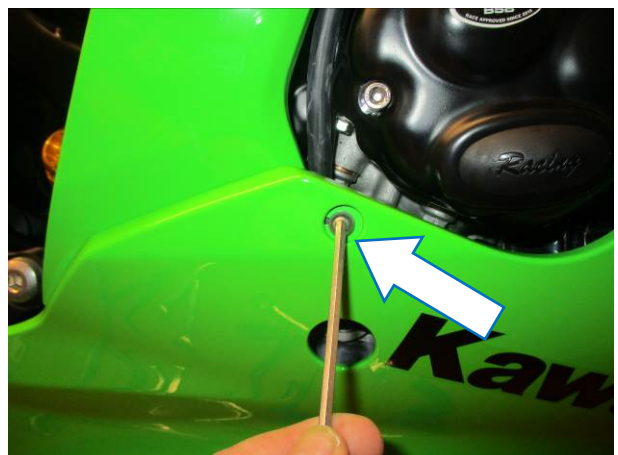

R&G



PICTURE 9

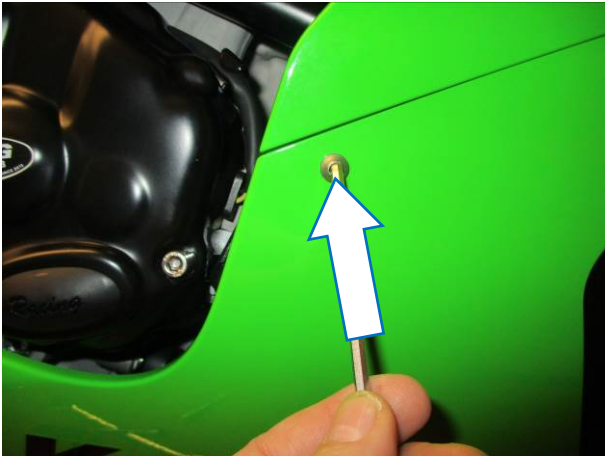

PICTURE 11

PICTURE 10



PICTURE 12



PICTURE 13

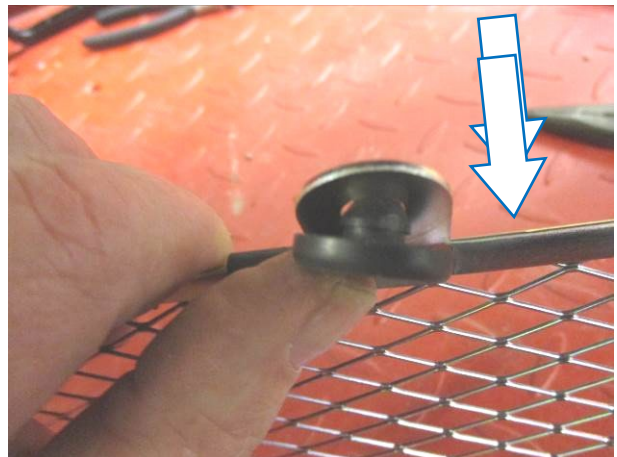

PICTURE 14

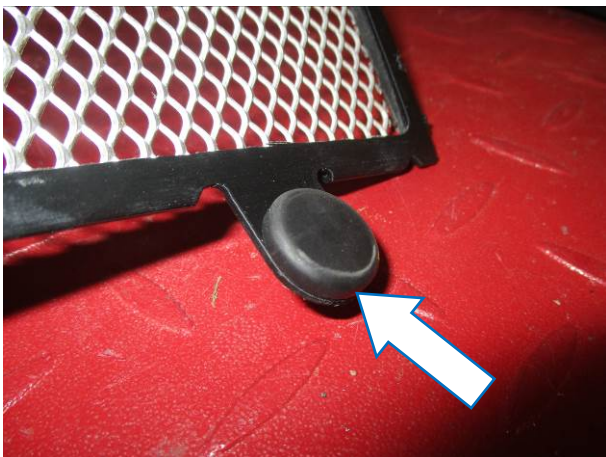

PICTURE 15



PICTURE 16



FITTING INSTRUCTIONS

Near side (left side as you sit on the motorcycle)

- Remove the three plastic rivets arrowed in **pictures 1 and 2**.
- Remove the five bolts arrowed in **pictures 3, 4, 5, 6 and 7**.
- Carefully remove the lower fairing.

Off side (right side as you sit on the motorcycle)

- Remove the five bolts arrowed in **pictures 9, 10, 11, 12 and 13**.
- Carefully remove the lower fairing.
- To fit the oil cooler guard to the bike, first cut the self-adhesive foam strip provided (**item 2**) into 10mm wide pieces and stick them to the back of the oil cooler guard frame (**item 1**), so that they will sit between the oil cooler and the oil cooler guard as shown in **below**.

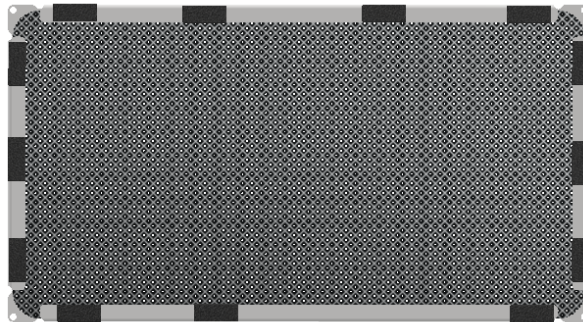

- Remove the original oil cooler guard.
- Remove both the rubber pads as shown in **picture 14** and fit to the new oil cooler guard as shown in **pictures 15 and 16**.
- Use the supplied cable ties (**item 3**) to secure the guard into position ensuring to pass the cable ties around the oil cooler frame and not the cooling matrix as shown below.

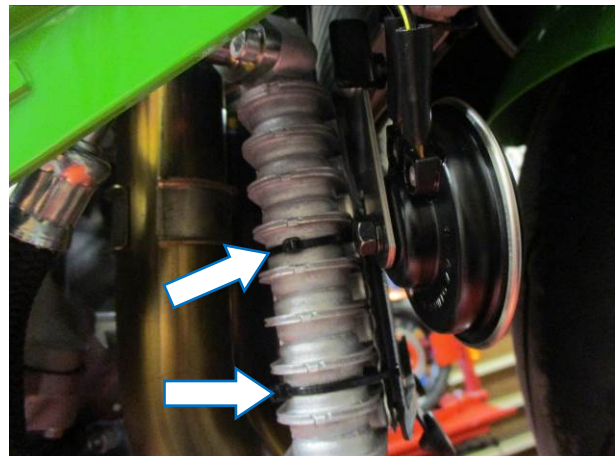
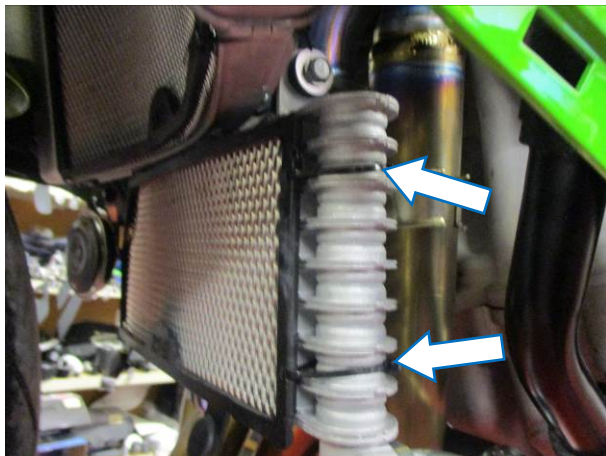

- Refit both fairings as original.

R&G

Unit 1, Shelley's Lane, East Worldham, Alton, Hampshire, GU34 3AQ

Tel: +44 (0)1420 89007 Fax: +44 (0)1420 87301 www.rg-racing.com Email: info@rg-racing.com



ISSUE 1 09/09/2021 (NSY)

CONSUMER NOTICE

The catalogue description and any exhibition of samples are only broad indications of the Products and R&G may make design changes which do not diminish their performance or visual appeal and supplying them in such state shall conform to the order. The Buyer acknowledges no representation or warranty (other than as to title) has been given or will apply to the Products other than those in R&G's order or confirmation and the Buyer confirms it has chosen the Products as being of merchantable quality and suitable for its particular purposes. Where R&G fits the Products or undertakes other services it shall exercise reasonable skill and care and rectify any fault free of charge unless the workmanship has been disturbed. The Buyer is responsible for ensuring that the warranty on the motorcycle is not affected by the fitting of the Products. On return of any defective Products R&G shall at its option either supply a replacement or refund the purchase money but shall not be liable if the Products have been modified or used or maintained otherwise than in accordance with R&G's or manufacturer's instructions and good engineering practice or if the defect arises from accident or neglect. Other than identified above and subject to R&G not limiting its liability for causing death and personal injury, it shall not be liable for indirect or consequential loss and otherwise its liability shall be limited to the amounts paid by the Buyer for the Products or the fitting or service concerned. These terms do not affect the Buyer's statutory rights.

R&G RETURNS POLICY (NON-FAULTY GOODS)

Returns must be pre-authorized (if not pre-authorized the return will be rejected). Goods may only be returned direct to us if they were purchased direct from us (customer must prove if necessary). Otherwise to be returned to original vendor. Goods must be in re-sellable condition, in the opinion of R&G. All returns are subject to a 25% restocking and handling fee (25% of the gross value exc. P&P – at the prevailing price at time of purchase). The customer must pay any and all carriage charges. No returns of discontinued products, unless within 14 days of purchase. This policy does not affect your statutory rights and does not refer to faulty goods.

R&G

Unit 1, Shelley's Lane, East Worldham, Alton, Hampshire, GU34 3AQ

Tel: +44 (0)1420 89007 Fax: +44 (0)1420 87301 www.rg-racing.com Email: info@rg-racing.com



NOTICE DE MONTAGE POUR SCG0017SS PROTECTION
REFROIDISSEUR D'HUILE
POUR KAWASAKI NINJA ZX-10R/RR 2021-

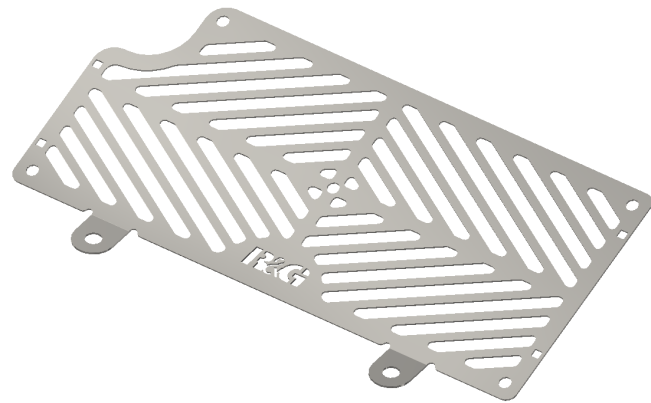

PHOTO A

THIS KIT CONTAINS THE ITEMS PHOTOD AND LABELLED OVER PAGE.

SOME PARTS MAY BE SHOWN FOR CLARITY OF INSTRUCTIONS ONLY.

DO NOT PROCEED UNTIL YOU ARE SURE ALL PARTS ARE PRESENT.

PLEASE READ ALL INSTRUCTIONS BEFORE PROCEEDING.

**IF IN ANY DOUBT WHEN FITTING OUR PRODUCTS, CONSULT ONE OF
OUR DEALERS OR HAVE FITTED BY A QUALIFIED TECHNICIAN.**

PLEASE NOTE THAT THE WAY THE KIT IS PACKED DOES NOT NECESSARILY REPRESENT THE
WAY OF MOUNTING TO THE BIKE.

IN THE EVENT OF RUBBER WASHERS BEING USED TO HOLD COMPONENTS ONTO BOLTS,
THESE RUBBER WASHERS CAN BE THROWN AWAY.

DIGITAL COPIES OF THESE INSTRUCTIONS ARE AVAILABLE FROM:

WWW.RG-RACING.COM



<u>TOOLS REQUIRED</u>	<u>GENERAL TORQUE SETTINGS</u>
<ul style="list-style-type: none"> • Allen key set to include 4 & 5mm A/F. <ul style="list-style-type: none"> • 10mm spanner or socket. • Phillips and flat bladed driver. <ul style="list-style-type: none"> • Cable cutters. 	<p>M4 BOLT = 8Nm M5 BOLT = 12Nm M6 BOLT = 15Nm M8 BOLT = 20Nm M10 BOLT = 40Nm M12 BOLT = 40Nm</p>

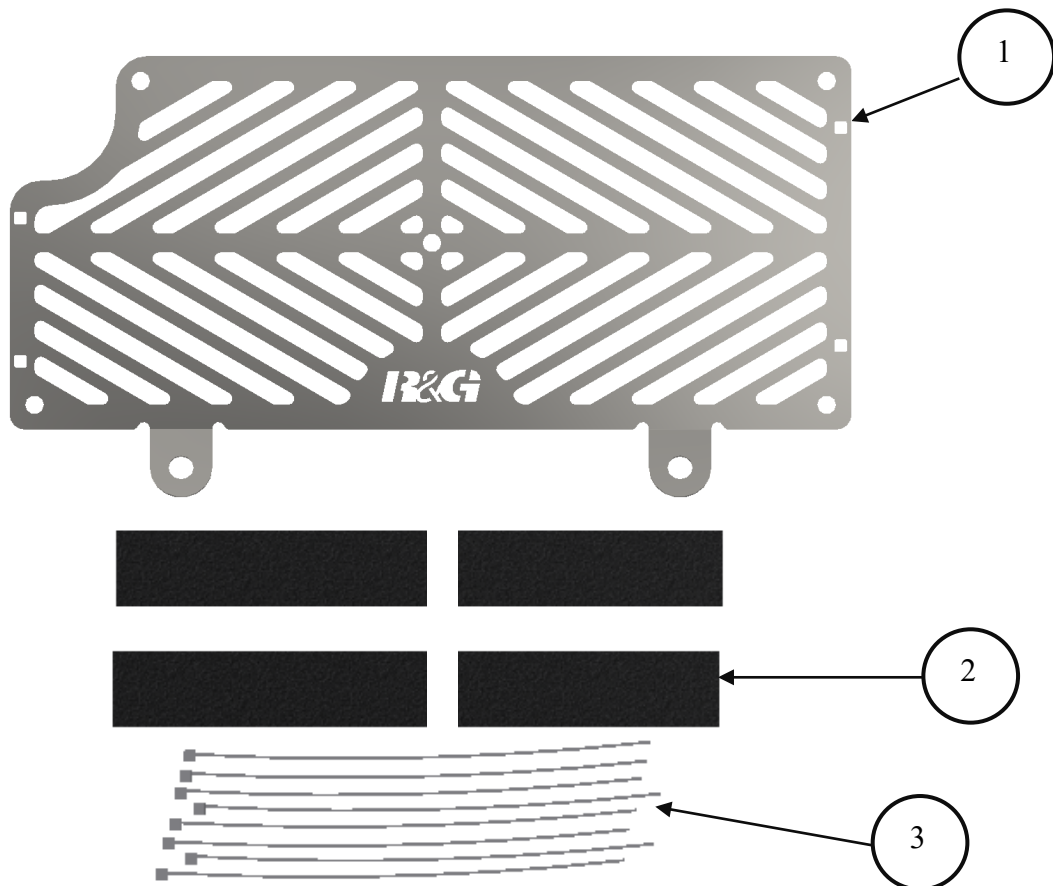

COMPONENT DIAGRAM



LEGEND

ITEM NO.	DESCRIPTION	QTY
ITEM 1	STAINLESS OIL COOLER GUARD (SCG0017SS)	1
ITEM 2	SELF ADHESIVE FOAM x 100mm LONG	4
ITEM 3	2.5mm CABLE TIES	8



PHOTO 1



PHOTO 2

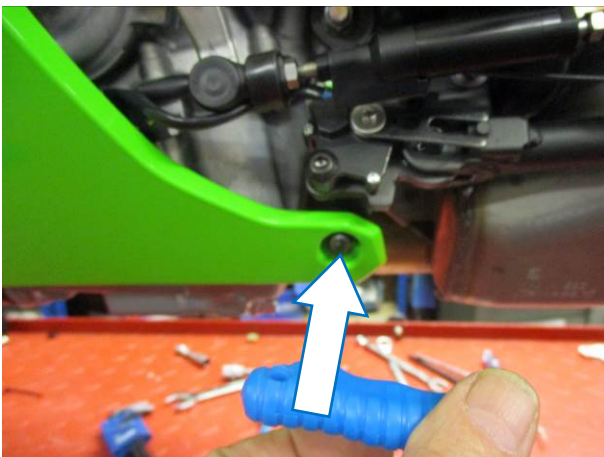

PHOTO 3



PHOTO 4



PHOTO 5

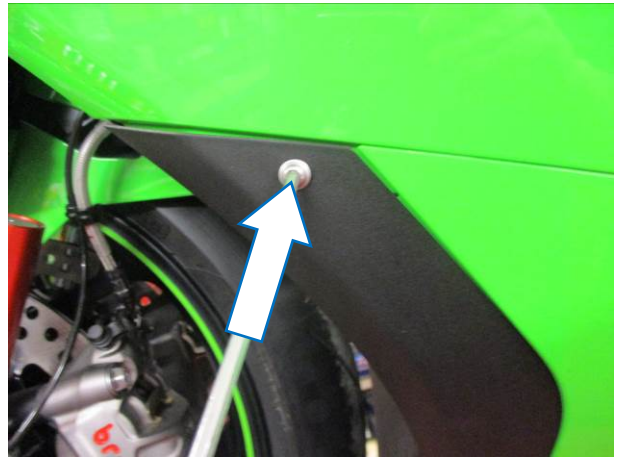

PHOTO 6

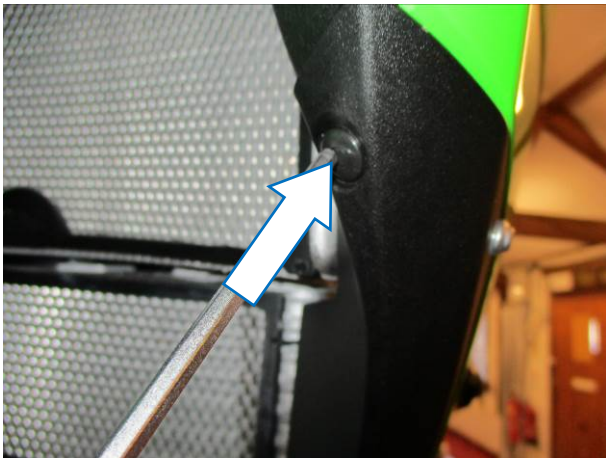

PHOTO 7

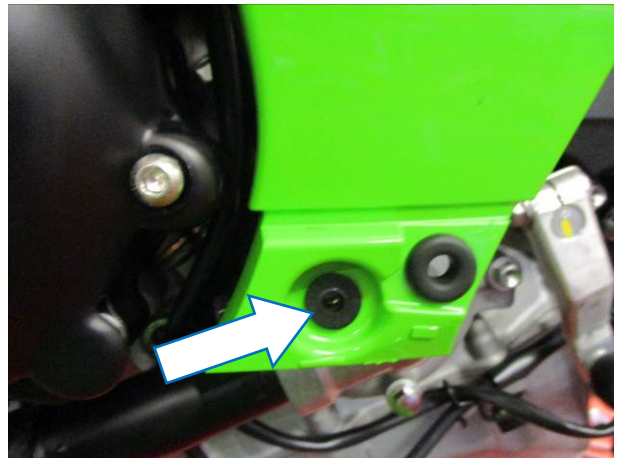
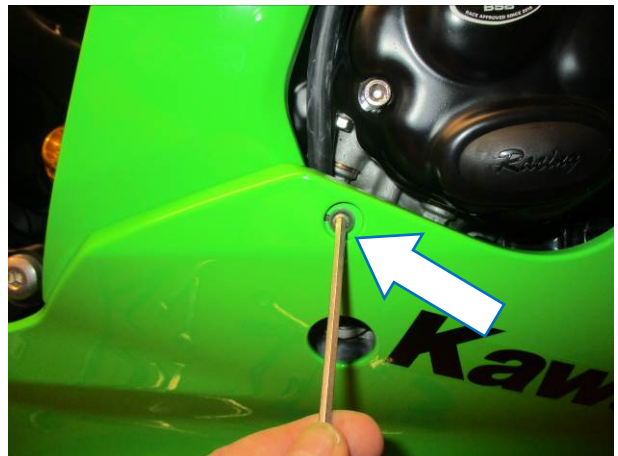

PHOTO 8



R&G



PHOTO 9

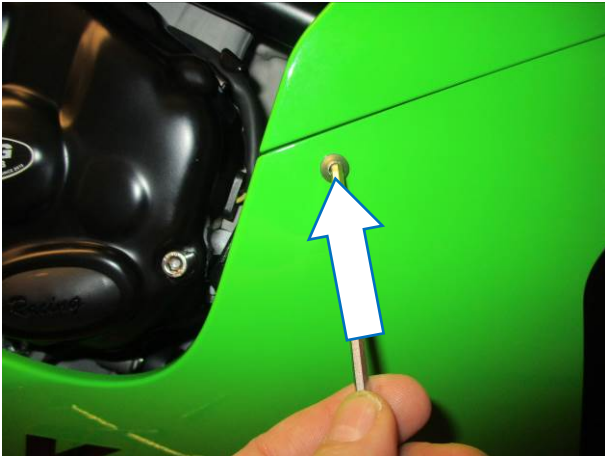

PHOTO 11

PHOTO 10



PHOTO 12



PHOTO 13

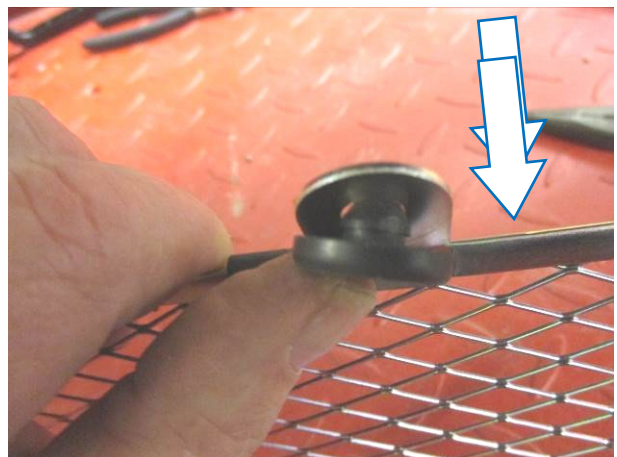

PHOTO 14

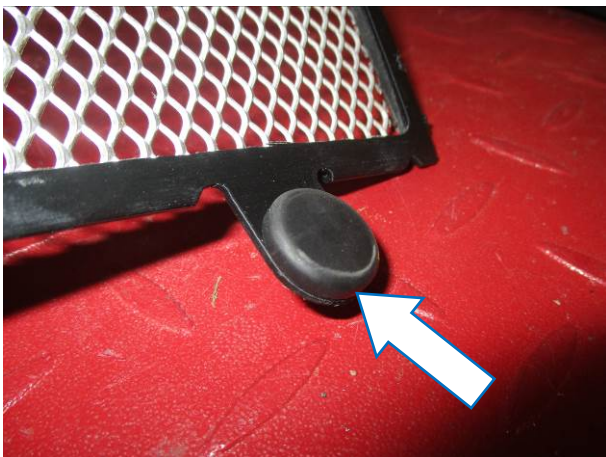

PHOTO 15



PHOTO 16



NOTICE DE MONTAGE

CÔTÉ GAUCHE (lorsqu'on est assis sur la moto)

- Retirez les trois rivets en plastique fléchés sur les photos 1 et 2.
- Retirez les cinq boulons indiqués sur les photos 3, 4, 5, 6 et 7.
- Retirez soigneusement le carénage inférieur.

CÔTÉ DROIT (lorsqu'on est assis sur la moto)

- Retirez les cinq boulons indiqués sur les photos 9, 10, 11, 12 et 13.
- Retirez avec précaution le carénage inférieur.
- Pour installer la protection du refroidisseur d'huile sur la moto, coupez d'abord la bande de mousse auto-adhésive fournie (élément 2) en morceaux de 10 mm de large et collez-les à l'arrière du cadre de protection du refroidisseur d'huile (article 1), de manière à ce qu'elles reposent entre le refroidisseur d'huile et la protection du refroidisseur d'huile comme illustré ci-dessous.

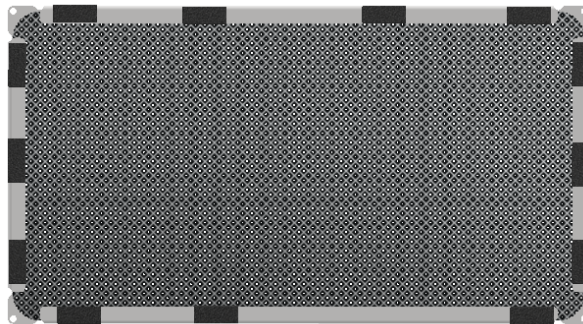

- Retirez la protection d'origine du refroidisseur d'huile.
- Retirez les deux patins en caoutchouc comme indiqué sur la photo 14 et installez-les sur la nouvelle protection du refroidisseur d'huile comme indiqué sur les photos 15 et 16.
- Utilisez les serre-câbles fournis (élément 3) pour fixer la protection en position en veillant à faire passer les serre-câbles autour du cadre du refroidisseur d'huile et non de la matrice de refroidissement comme indiqué ci-dessous :

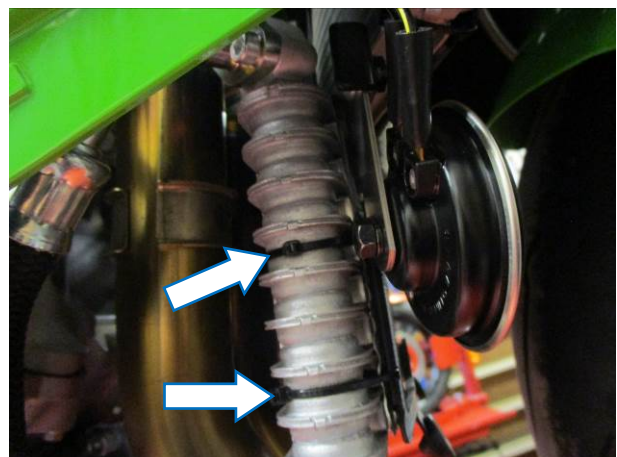
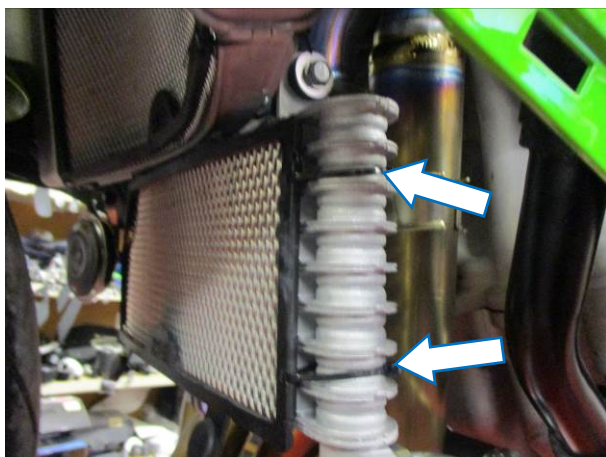

R&G



- Remonter les 2 carénages comme à l'origine.

ISSUE 1 09/09/2021 (NSY)

CONSUMER NOTICE

The catalogue description and any exhibition of samples are only broad indications of the Products and R&G may make design changes which do not diminish their performance or visual appeal and supplying them in such state shall conform to the order. The Buyer acknowledges no representation or warranty (other than as to title) has been given or will apply to the Products other than those in R&G's order or confirmation and the Buyer confirms it has chosen the Products as being of merchantable quality and suitable for its particular purposes. Where R&G fits the Products or undertakes other services it shall exercise reasonable skill and care and rectify any fault free of charge unless the workmanship has been disturbed. The Buyer is responsible for ensuring that the warranty on the motorcycle is not affected by the fitting of the Products. On return of any defective Products R&G shall at its option either supply a replacement or refund the purchase money but shall not be liable if the Products have been modified or used or maintained otherwise than in accordance with R&G's or manufacturer's instructions and good engineering practice or if the defect arises from accident or neglect. Other than identified above and subject to R&G not limiting its liability for causing death and personal injury, it shall not be liable for indirect or consequential loss and otherwise its liability shall be limited to the amounts paid by the Buyer for the Products or the fitting or service concerned. These terms do not affect the Buyer's statutory rights.

R&G RETURNS POLICY (NON-FAULTY GOODS)

Returns must be pre-authorized (if not pre-authorized the return will be rejected). Goods may only be returned direct to us if they were purchased direct from us (customer must prove if necessary). Otherwise to be returned to original vendor. Goods must be in re-sellable condition, in the opinion of R&G. All returns are subject to a 25% restocking and handling fee (25% of the gross value exc. P&P – at the prevailing price at time of purchase). The customer must pay any and all carriage charges. No returns of discontinued products, unless within 14 days of purchase. This policy does not affect your statutory rights and does not refer to faulty goods.

R&G

Unit 1, Shelley's Lane, East Worldham, Alton, Hampshire, GU34 3AQ
Tel: +44 (0)1420 89007 Fax: +44 (0)1420 87301 www.rg-racing.com Email: info@rg-racing.com



**MONTAGEANLEITUNG FÜR SCG0017SS ÖLKÜHLERSCHUTZ
FÜR KAWASAKI NINJA ZX-10R/RR 2021-**



ABBILDUNG A

**ALLE KIT-TEILE SIND AUF DEN NACHFOLGENDEN SEITEN ABGEBILDET UND
GEKENNZEICHNET.**

DIE ABGEBILDETEN TEILE DIENEN LEDIGLICH ZUR ERKLÄRUNG.

ÜBERPRÜFEN SIE ZUERST, DASS ALLE TEILE VORHANDEN SIND.

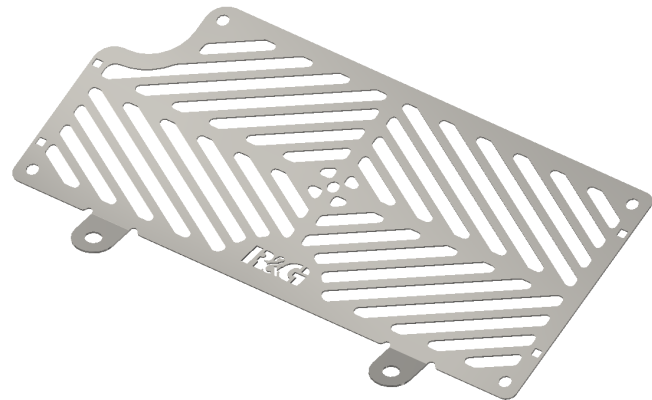
LESEN SIE DIE MONTAGEANLEITUNG KOMPLETT DURCH, BEVOR SIE ANFANGEN.

**WENN SIE BEI DER MONTAGE DIESES PRODUKTES UNSICHER SIND,
BITTE EINEN UNSERER HÄNDLER KONTAKTIEREN ODER DAS KIT VON
EINEM QUALIFIZIERTEN ZWEIRAD-MECHANIKER MONTIEREN LASSEN.**

DIE VERPACKUNG DER TEILE STELLT NICHT DIE REIHENFOLGE DER MONTAGE DAR.

HINWEIS FÜR KITS MIT PLASTIKUNTERLEGSCHLEIBEN AN DEN SCHRAUBEN –
DIESE PLASTIK-UNTERLEGSCHLEIBEN WERDEN NICHT FÜR DEN EINBAU BENÖTIGT

**EINE DIGITALE VERSION DIESER MONTAGEANLEITUNG KANN AUF
FOLGENDER SEITE HERUNTERGELADEN WERDEN:**

WWW.RG-RACING.COM



SIE BENÖTIGEN FOLGENDES WERKZEUG	ALLGEM. ANZUGSDREHMOMENTE
<ul style="list-style-type: none"> • Satz Inbusschlüssel inkl. 4 & 5mm A/F <ul style="list-style-type: none"> • 10mm Steckschlüssel oder Schraubenschlüssel • Schraubenzieher (Kreuzschlitz und flachen Schraubenzieher) <ul style="list-style-type: none"> • Seitenschneider 	<p>M4 SCHRAUBE = 8Nm M5 SCHRAUBE = 12Nm M6 SCHRAUBE = 15Nm M8 SCHRAUBE = 20Nm M10 SCHRAUBE = 40Nm M12 SCHRAUBE = 40Nm</p>

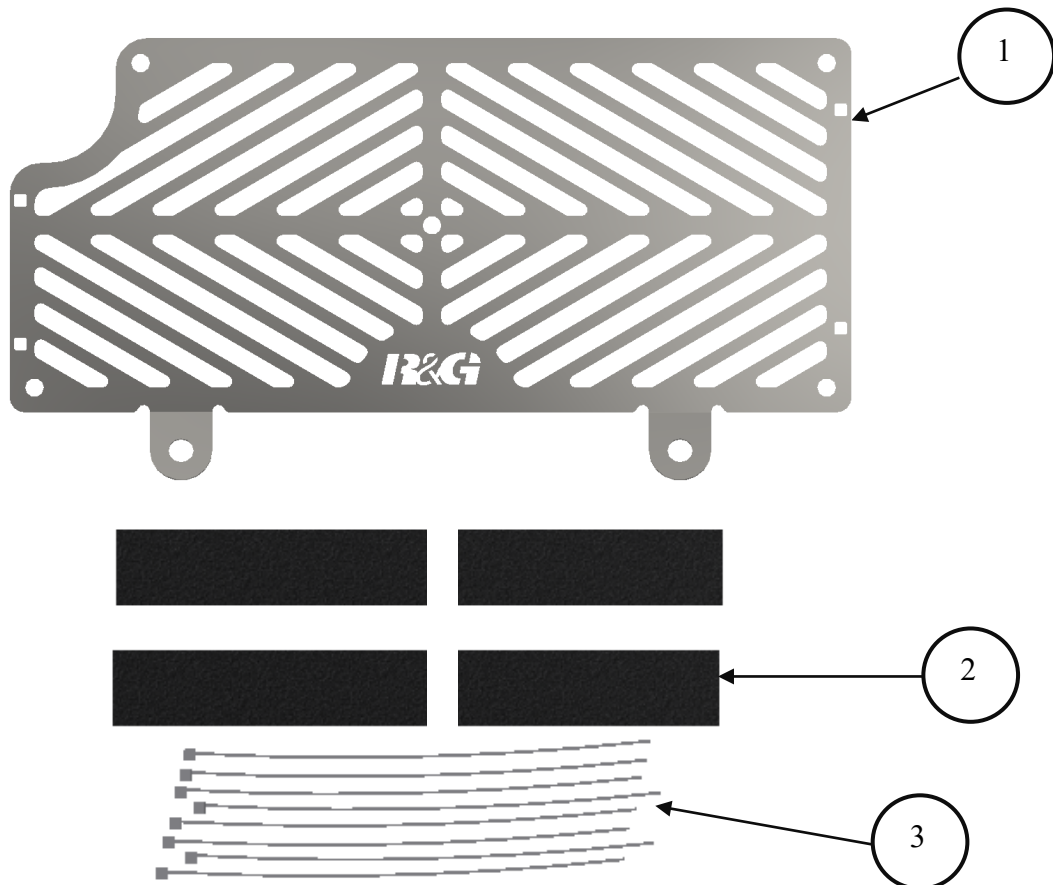

KIT-TEILE - ZEICHNUNG



LIEFERUMFANG

ARTIKEL NR.	BESCHREIBUNG	MENGE
ARTIKEL 1	ÖLKÜHLERSCHUTZ (SCG0017SS)	1
ARTIKEL 2	SELBSTKLEBENDER SCHAUMSTOFF x 100mm LÄNGE	4
ARTIKEL 3	2,5mm KABELBINDER	8



ABBILDUNG 1



ABBILDUNG 2



ABBILDUNG 3



ABBILDUNG 4

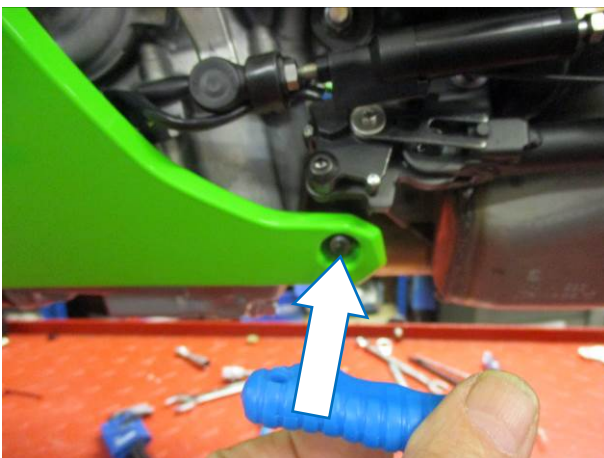

ABBILDUNG 5



ABBILDUNG 6



ABBILDUNG 7

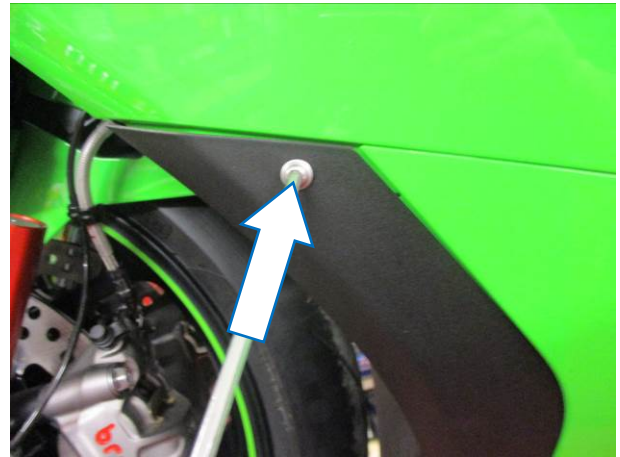

ABBILDUNG 8

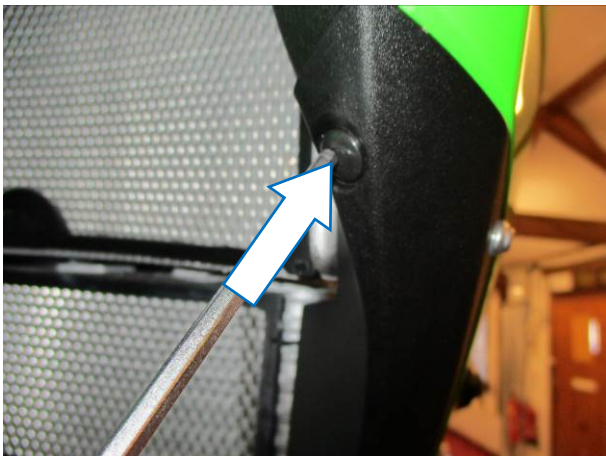

ABBILDUNG 9

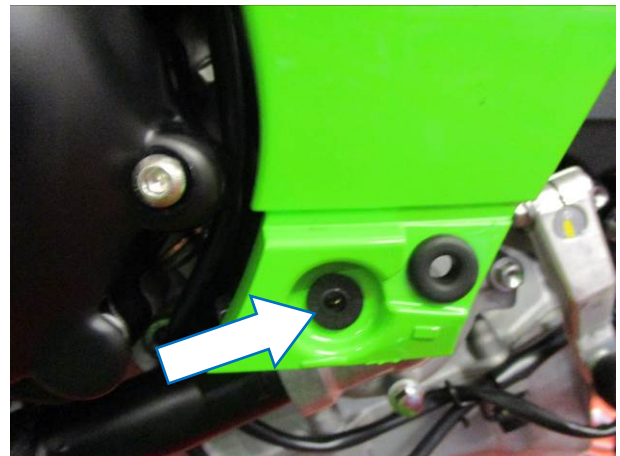

ABBILDUNG 10



ABBILDUNG 11

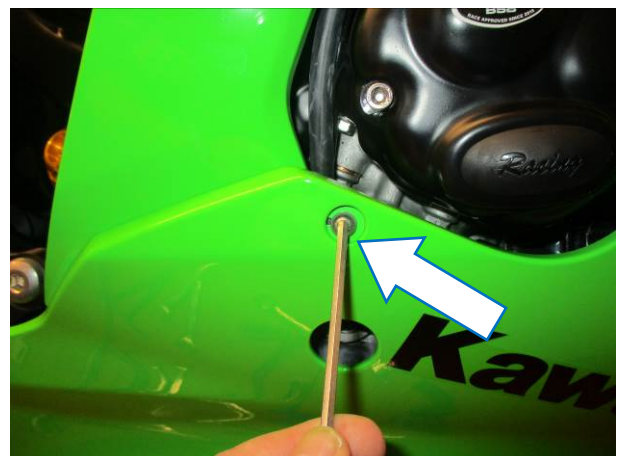

ABBILDUNG 12

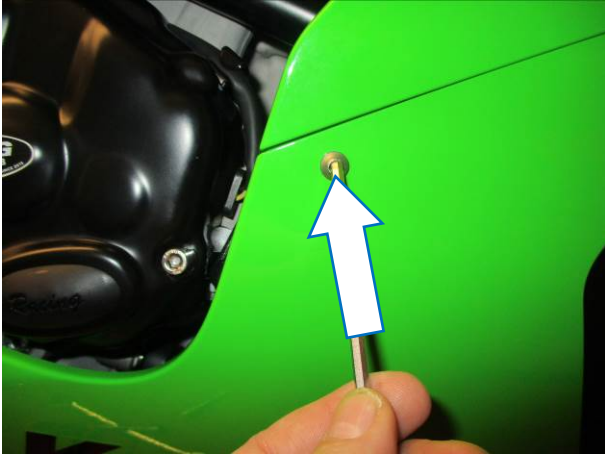

ABBILDUNG 13

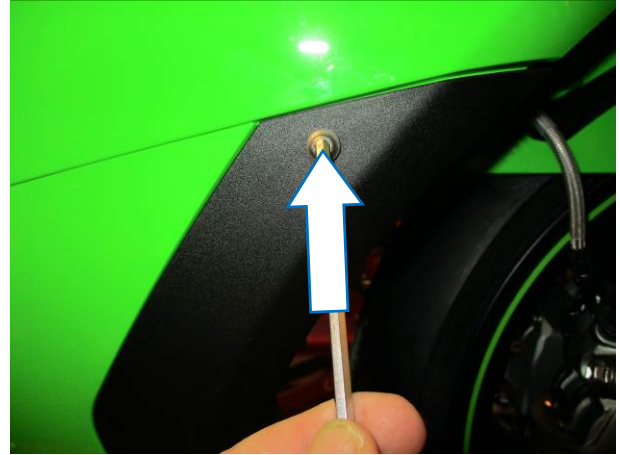

ABBILDUNG 14



ABBILDUNG 15

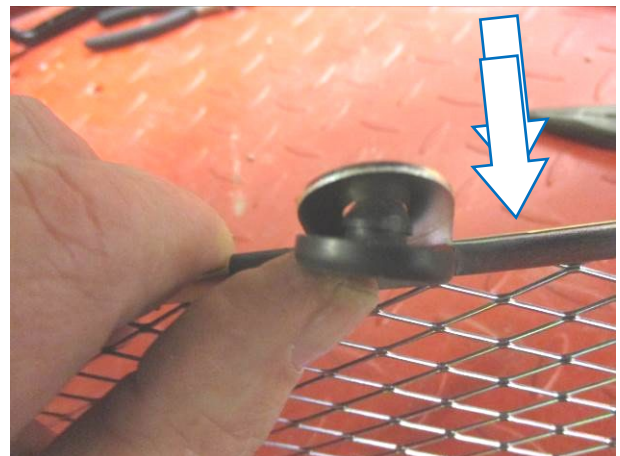

ABBILDUNG 16



MONTAGEANLEITUNG

Linke Seite (in Fahrtrichtung)

- Entfernen Sie die drei Plastiknieten, die in den **Abbildungen 1 und 2** markiert sind.
- Entfernen Sie die fünf Schrauben, die in den **Abbildungen 3, 4, 5, 6 und 7** gekennzeichnet sind.
- Entfernen Sie vorsichtig die untere Verkleidung.

Rechte Seite (in Fahrtrichtung)

- Entfernen Sie die fünf Schrauben, die in den **Abbildungen 9, 10, 11, 12 und 13** gekennzeichnet sind.
- Entfernen Sie nun vorsichtig die untere Verkleidung.
- Um den Ölkühlerschutz am Motorrad montieren zu können, schneiden Sie die mitgelieferten Schaumstoffstreifen (**Artikel 2**) in 10 mm breite Streifen und kleben Sie diese auf der Rückseite des Kühlerschutzrahmens (**Artikel 1**), so dass sie zwischen dem Ölkühler und dem Ölkühlerschutz angebracht sind wie in **unten abgebildet**.

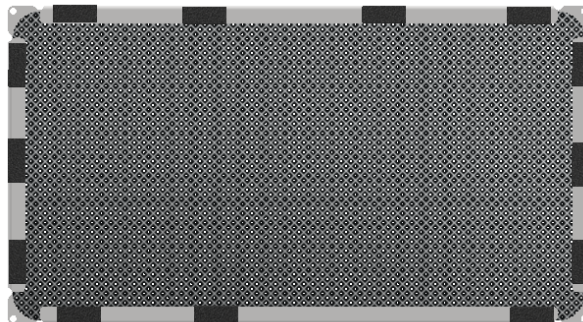

- Entfernen Sie den original Ölkühlerschutz.
- Entfernen Sie die zwei Gummischeiben, die in **Abbildung 14** abgebildet sind und montieren Sie den neuen Ölkühlerschutz wie in den **Abbildungen 15 und 16** abgebildet.
- Benutzen Sie die Kabelbinder vom Kit (**Artikel 3**), um den Kühlerschutz in Position zu befestigen. Stellen Sie sicher, dass die Kabelbinder montiert werden wie unten abgebildet (durch den Kühlerrahmen gefädelt, nicht durch das Gitter des Kühlerschutz):

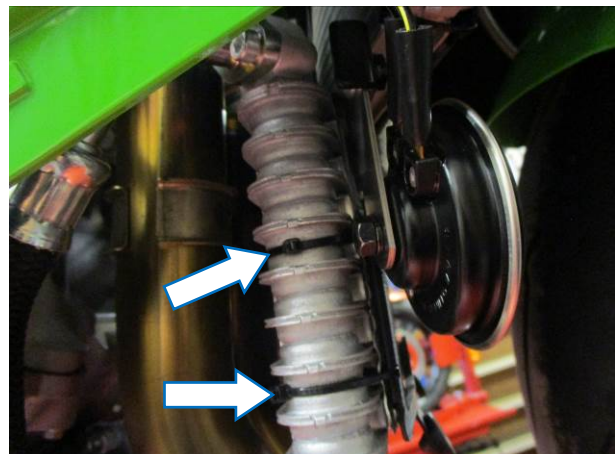
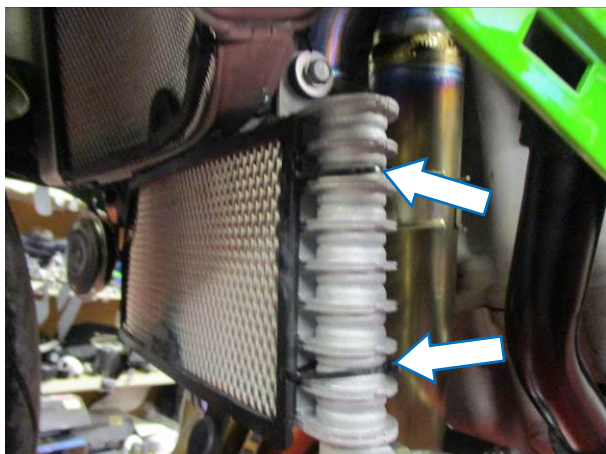

R&G



- Montieren Sie beide Verkleidungen wie ursprünglich wieder.

AUSGABE 1 09/09/2021 (NSY)

CONSUMER NOTICE

The catalogue description and any exhibition of samples are only broad indications of the Products and R&G may make design changes which do not diminish their performance or visual appeal and supplying them in such state shall conform to the order. The Buyer acknowledges no representation or warranty (other than as to title) has been given or will apply to the Products other than those in R&G's order or confirmation and the Buyer confirms it has chosen the Products as being of merchantable quality and suitable for its particular purposes. Where R&G fits the Products or undertakes other services it shall exercise reasonable skill and care and rectify any fault free of charge unless the workmanship has been disturbed. The Buyer is responsible for ensuring that the warranty on the motorcycle is not affected by the fitting of the Products. On return of any defective Products R&G shall at its option either supply a replacement or refund the purchase money but shall not be liable if the Products have been modified or used or maintained otherwise than in accordance with R&G's or manufacturer's instructions and good engineering practice or if the defect arises from accident or neglect. Other than identified above and subject to R&G not limiting its liability for causing death and personal injury, it shall not be liable for indirect or consequential loss and otherwise its liability shall be limited to the amounts paid by the Buyer for the Products or the fitting or service concerned. These terms do not affect the Buyer's statutory rights.

R&G RETURNS POLICY (NON-FAULTY GOODS)

Returns must be pre-authorized (if not pre-authorized the return will be rejected). Goods may only be returned direct to us if they were purchased direct from us (customer must prove if necessary). Otherwise to be returned to original vendor. Goods must be in re-sellable condition, in the opinion of R&G. All returns are subject to a 25% restocking and handling fee (25% of the gross value exc. P&P – at the prevailing price at time of purchase). The customer must pay any and all carriage charges. No returns of discontinued products, unless within 14 days of purchase. This policy does not affect your statutory rights and does not refer to faulty goods.

R&G

Unit 1, Shelley's Lane, East Worldham, Alton, Hampshire, GU34 3AQ
Tel: +44 (0)1420 89007 Fax: +44 (0)1420 87301 www.rg-racing.com Email: info@rg-racing.com